

Data Sheet



Article number: 021816011254

Description: Clamp with bracket and rubber
SPGU 6011. 254/30 SK

Measures

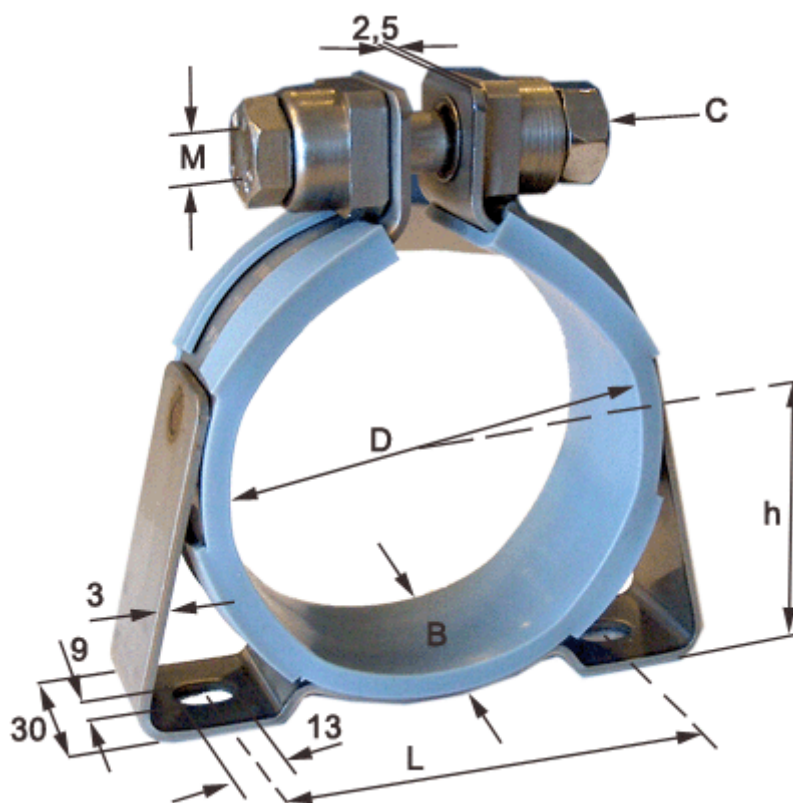

C (screw type) = SK hexagon screw

Diameter D = 254

h = 135

L = 248

Width B = 30